

T039WWR940CADB | ZENO 130

Professional adjustable LED projector

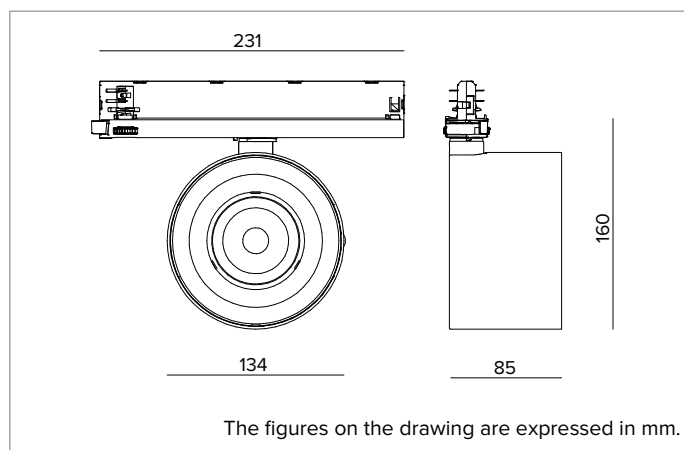

	4000K	H(m)	D1(m)	D2(m)	E _{max} (lx)
	Ra90	34°	54°		
Fixture Power	29W	1	1.06	1.16	1664
Source Flux	3243lm	2	2.11	2.33	416
Fixture Flux	1835lm	3	3.17	3.49	185
Efficacy	62lm/W	4	4.23	4.65	104
TS1224	I _{max} =745cd/klm	I _{max}	2417cd	5	5.28
			5.81		67



SOURCE

High efficiency Chip on Board LED Ra90. Ra97 on request.

Energy efficiency class: E

Nominal power: 26W

Nominal flux: 3243lm

Colour rendering index: 90

Rf: 90

Rg: 98

CCT nominal: 4000K

Lifetime (L80/B10): >50000h tq +25°C

ILLUMINOTECHNICAL CHARACTERISTICS

Wall Washer version with a highly reflective pre-anodised specular aluminium optic, a PMMA holographic screen and a black polymer covering element.

Optic: WALL WASHER

Beam angles: WW

Optical efficiency: 57%

Fixture flux: 1835lm

Luminous efficacy: 62lm/W

Photobiological safety: Compliant with RG1 low risk group

MECHANICAL CHARACTERISTICS

Die-cast painted aluminium optical unit. The optical unit can be adjusted from 0 to -90° on the vertical plane; and 355° on the horizontal plane with aiming blocking system.

Colour and finish: Deep black

Weight: 0.85Kg

Degree of protection: IP20

ELECTRICAL CHARACTERISTICS

CASAMBI electronic driver integrated into the track adapter.

Fixture Power: 29W

Power supply: 220-240Vac 50/60Hz

Insulation Class: CLASS 2

Type of driver / Control: CASAMBI

Driver included: YES

Class F: YES

SAFE FLICKER: PstLM=<1 and SVM=<0.4 (IEC TR 61547-1 and IEC TR 63158), to ensure a more comfortable and safe light

Ambient temperature: 0°C / +25°C

INSTALLATION

Electrified track mounting. Mechanical and optic accessories available, to be installed with holder ring (necessary).

NOTES

110-277Vac version available on request. Commissioning of the control system via free APP; the intervention of a specialist technician can be quoted on request.

WARRANTY

5 years.

WARNING

Luminaire designed for disposal/recycling at end-of-life. Replaceable (LED only) light source by a professional. Replaceable control gear by a professional.

Due to the technological evolution of the electronic components, the data provided may be updated, and as such, confirmation must be requested during the order process.

Luminous flux and power supply have +/-10% tolerances with respect to the indicated value. tq +25°C (CIE 121).

We reserve the right to make technical changes.

Targetti Sankey S.r.l.
Via Pratese, 164
50145 Firenze - Italy
Tel: +39 055 37911
targetti.com
targetti@targetti.com

CCIAA Firenze
Share Capital:
€ 500.000,00
VAT N. (IT):
01537660480
R.E.A.: FI-275656

TARGETTI